



± 2g / 4g / 6g / 8g Tri-axis Digital Accelerometer Specifications

PART NUMBER:

KXCNL-1010
Rev 3.0

Product Description

The KXCNL-1010 is a tri-axis +/-2g, +/-4g, +/-6g, or +/-8g silicon micromachined accelerometer with integrated programmable state machines. The sense element is fabricated using Kionix's proprietary plasma micromachining process technology. Acceleration sensing is based on the principle of a differential capacitance arising from acceleration-induced motion of the sense element, which further utilizes common mode cancellation to decrease errors from process variation, temperature, and environmental stress. The sense element is hermetically sealed at the wafer level by bonding a second silicon lid wafer to the device using a glass frit. A separate ASIC device packaged with the sense element provides signal conditioning, and intelligent user-programmable state machines. The accelerometer is delivered in a 3 x 3 x 0.9 mm LGA plastic package operating from a 1.8 – 3.6V DC supply. I²C interface is used to communicate to the chip to load state programs, configure settings, and check updates to the acceleration data.

Functional Diagram

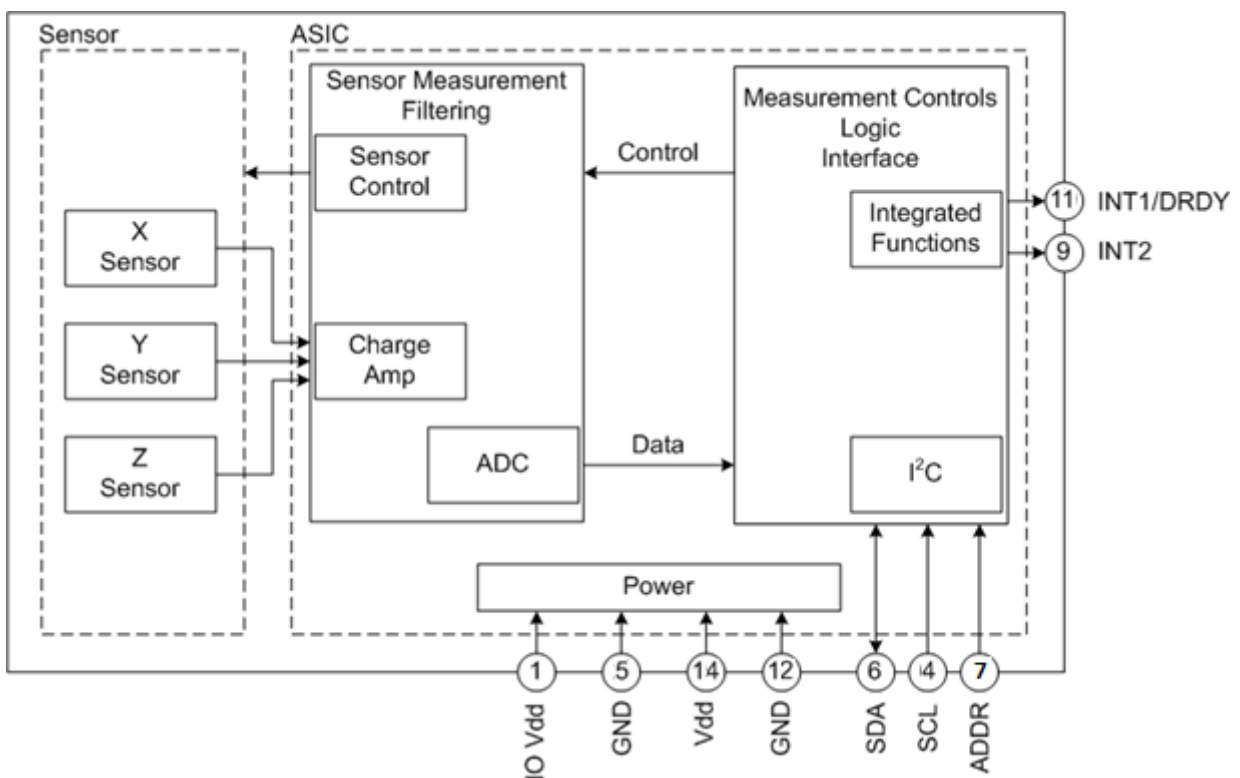



± 2g / 4g / 6g / 8g Tri-axis Digital Accelerometer Specifications

PART NUMBER:

KXCNL-1010
Rev 3.0

Product Specifications

Table 1. Mechanical

(specifications are for 12-bit operation at 2.5V and T = 25C unless stated otherwise)

Parameters		Units	Min	Typical	Max
Operating Temperature Range		°C	-40	-	85
Zero-g Offset		mg		±25	
Zero-g Offset Variation from RT over Temp.		mg/°C		0.5 (xy), 0.8 (z)	
Sensitivity ¹	SC_1=0, SC_0=0 (± 2g)	counts/g		1024	
	SC_1=0, SC_0=1 (± 4g)			512	
	SC_1=1, SC_0=0 (± 6g)			341	
	SC_1=1, SC_0=1 (± 8g)			256	
Sensitivity Variation from RT over Temp.		%/°C		0.01	
Self Test Output change on Activation		g		0.5 (x) 0.7 (y) 0.7 (z)	
Mechanical Resonance (-3dB) ²		Hz		3500 (xy) 1800 (z)	
Non-Linearity		% of FS		0.5	
Cross Axis Sensitivity		%		2	
Noise ³		µg/sqrt(Hz)		400	

Notes:

1. Acceleration ranges are user selectable via I²C.
2. Resonance as defined by the dampened mechanical sensor.
3. Measured in ± 2g range and including variation over operating temperature range at ODR5 (100Hz).

	± 2g / 4g / 6g / 8g Tri-axis Digital Accelerometer Specifications	PART NUMBER: KXCNL-1010 Rev 3.0
---	--	--

Table 2. Electrical

(specifications are for operation at 2.5V and T = 25C unless stated otherwise)

Parameters		Units	Min	Typical	Max
Supply Voltage (V _{dd})	Operating	V	1.7	2.5	3.6
I/O Pads Supply Voltage (V _{IO})		V	1.12	2.5	V _{dd}
Current Consumption	Active-mode ODR7	μA		150	
	Active- mode ODR5			125	
	Active-mode ODR0			35	
	Standby-mode			0.2	
	Off-mode Leakage			0.2	
Output Low Voltage (V _{OL}) ¹		V			0.2 * V _{IO}
Output High Voltage (V _{OH})		V	0.8 * V _{IO}		
Input Low Voltage (V _{IL})		V	0		0.3 * V _{IO}
Input High Voltage (V _{IH})		V	0.7 * V _{IO}		V _{IO}
Input Pull-down Current		μA		0	
Power Up Time ²		ms		3	
Start Up Time ³		ms		2	
Turn Off Time ⁴		ms		1	
Interrupt Pulse Width (when pulse selected)		μs		100	
I ² C Communication Rate ⁵		MHz			3.4
Output Data Rate (ODR) ⁶		Hz	3.125	100	1600
Bandwidth (-3dB) ⁷		Hz		ODR/2	

Notes:

1. Assuming I²C communication and minimum 1.5Kohm pull-up resistor on SCL and SDA pins.
2. Power up time is from V_{IO} and V_{dd} valid to device boot completion. (Off-mode to Standby-mode)
3. Start up time is from Standby-mode to Active-mode.
4. Turn off time is from Active-mode to Standby-mode
5. Supports I²C Standard speed (100kHz), Fast speed (400kHz), and High speed (3.4MHz)
6. User selectable through I²C.
7. User selectable and dependant on ODR.

	± 2g / 4g / 6g / 8g Tri-axis Digital Accelerometer Specifications	PART NUMBER: KXCNL-1010 Rev 3.0
---	--	--

Table 3. Environmental

Parameters		Units	Min	Typical	Max
Supply Voltage (V _{dd})	Absolute Limits	V	-0.3	-	4.0
Operating Temperature Range		°C	-40	-	85
Storage Temperature Range		°C	-55	-	150
Mech. Shock (powered and unpowered)		g	-	-	5000 for 0.5ms 10000 for 0.2ms
ESD	HBM	V	-	-	2000
	MM		-	-	200
	CDM		-	-	500



Caution: ESD Sensitive and Mechanical Shock Sensitive Component, improper handling can cause permanent damage to the device.



This product conforms to Directive 2002/95/EC of the European Parliament and of the Council of the European Union (RoHS). Specifically, this product does not contain lead, mercury, cadmium, hexavalent chromium, polybrominated biphenyls (PBB), or polybrominated diphenyl ethers (PBDE) above the maximum concentration values (MCV) by weight in any of its homogenous materials. Homogenous materials are "of uniform composition throughout."



This product is halogen-free per IEC 61249-2-21. Specifically, the materials used in this product contain a maximum total halogen content of 1500 ppm with less than 900-ppm bromine and less than 900-ppm chlorine.

Floor Life

Factory floor life exposure of the KXCNL reels removed from the moisture barrier bag should not exceed a maximum of 168 hours at 30C/70%RH. If this floor life is exceeded, the parts should be dried per the IPC/JEDEC J-STD-033A standard.

	± 2g / 4g / 6g / 8g Tri-axis Digital Accelerometer Specifications	PART NUMBER: KXCNL-1010 Rev 3.0
---	--	--

Terminology

g

A unit of acceleration equal to the acceleration of gravity at the earth's surface.

$$1g = 9.8 \frac{m}{s^2}$$

One thousandth of a g (0.0098 m/ s²) is referred to as 1 milli-g (1 mg).

Sensitivity

The sensitivity of an accelerometer is the change in output per unit of input acceleration at nominal V_{dd} and temperature. The term is essentially the gain of the sensor expressed in counts per g (counts/g) or LSB's per g (LSB/g). Occasionally, sensitivity is expressed as a resolution, i.e. milli-g per LSB (mg/LSB) or milli-g per count (mg/count). Sensitivity for a given axis is determined by measurements of the formula:

$$Sensitivity = \frac{(Output @ +1g - Output @ -1g)}{2g}$$

The sensitivity tolerance describes the range of sensitivities that can be expected from a large population of sensors at room temperature and over life. When the temperature deviates from room temperature (25°C), the sensitivity will vary by the amount shown in Table 1.

Zero-g offset

Zero-g offset or 0-g offset describes the actual output of the accelerometer when no acceleration is applied. Ideally, the output would always be in the middle of the dynamic range of the sensor (content of the OUTX, OUTY, OUTZ registers = 00h, expressed as a 2's complement number). However, because of mismatches in the sensor, calibration errors, and mechanical stress, the output can deviate from 00h. This deviation from the ideal value is called 0-g offset. The zero-g offset tolerance describes the range of 0-g offsets of a population of sensors over the operating temperature range.

Self-test

Self-test allows a functional test of the sensor without applying a physical acceleration to it. When activated, an electrostatic force is applied to the sensor, simulating an input acceleration. The sensor outputs respond accordingly. If the output signals change within the amplitude specified in Table 1, then the sensor is working properly and the parameters of the interface chip are within the defined specifications.

	± 2g / 4g / 6g / 8g Tri-axis Digital Accelerometer Specifications	PART NUMBER: KXCNL-1010 Rev 3.0
---	--	--

Functionality

Sense element

The sense element is fabricated using Kionix's proprietary plasma micromachining process technology. This process technology allows Kionix to create mechanical silicon structures which are essentially mass-spring systems that move in the direction of the applied acceleration. Acceleration sensing is based on the principle of a differential capacitance arising from the acceleration-induced motion. Capacitive plates on the moving mass move relative to fixed capacitive plates anchored to the substrate. The sense element is hermetically sealed at the wafer level by bonding a second silicon lid wafer to the device using a glass frit.

ASIC interface

A separate ASIC device packaged with the sense element provides all of the signal conditioning and communication with the sensor. The complete measurement chain is composed by a low-noise capacitance to voltage amplifier which converts the differential capacitance of the MEMS sensor into an analog voltage that is sent through an analog-to-digital converter. The acceleration data may be accessed through the I²C digital communications provided by the ASIC. In addition, the ASIC contains all of the logic to allow the user to choose data rates, g-ranges, filter settings, and interrupt logic. Plus, there are two programmable state machines which allow the user to create unique embedded functions based on changes in acceleration.

Factory calibration

Kionix trims the offset and sensitivity of each accelerometer by adjusting gain (sensitivity) and 0-g offset trim codes stored in non volatile memory (OTP). Additionally, all functional register default values are also programmed into the non volatile memory. Every time the device is turned on or a software reset command is issued, the trimming parameters and default register values are downloaded into the volatile registers to be used during active operation. This allows the device to function without further calibration.



± 2g / 4g / 6g / 8g Tri-axis Digital Accelerometer Specifications

PART NUMBER:
KXCNL-1010
Rev 3.0

Application Schematic

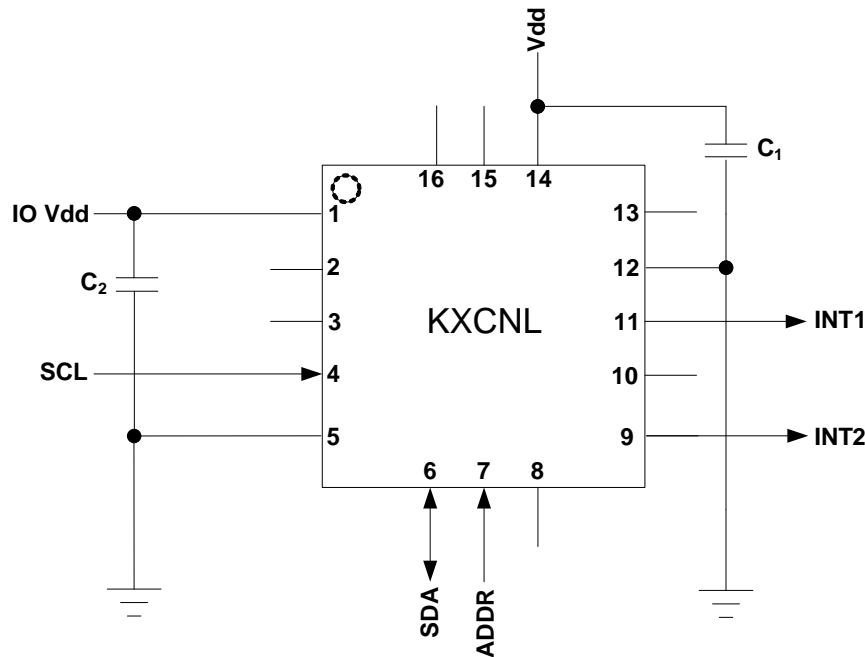

Table 4. KXCNL Pin Descriptions

Pin	Name	Description
1	V _{IO}	The power supply input for the digital logic and communication bus. Decouple this pin to ground with a 0.001 - 0.01uF ceramic capacitor.
2	NC	Not Connected Internally.
3	NC	Not Connected Internally.
4	SCL	I ² C Serial Clock
5	GND	Ground
6	SDA	I ² C Serial Data
7	ADDR	I ² C Address selection. Connect to V _{IO} or GND to select I ² C slave address.
8	NC	Not Connected Internally.
9	INT2	Physical Interrupt 2
10	NC	Not Connected Internally.
11	INT1	Physical Interrupt 1 / Data Ready
12	GND	Ground
13	NC	Not Connected Internally.
14	Vdd	The main power supply input. Decouple this pin to ground with a 0.1 - 0.47uF ceramic capacitor.
15	NC	Not Connected Internally.
16	NC	Not Connected Internally.

	± 2g / 4g / 6g / 8g Tri-axis Digital Accelerometer Specifications	PART NUMBER: KXCNL-1010 Rev 3.0
---	--	--

Test Specifications

! *Special Characteristics:*

These characteristics have been identified as being critical to the customer. Every part is tested to verify its conformance to specification prior to shipment.

Table 5. Test Specifications

Parameter	Specification	Test Conditions
Current consumption ODR7	<250uA	25C, Vdd = 2.5 V
Offset	150mg	25C, Vdd = 2.5 V
ODR clock accuracy	10%	25C, Vdd = 2.5 V

All specifications in Tables 1, 2, and 3 which are not listed in Table 5 (above) are tested on an audit or validation basis only and are not guaranteed to be within the minimum and maximum values prior to shipment.



± 2g / 4g / 6g / 8g Tri-axis Digital Accelerometer Specifications

PART NUMBER:

KXCNL-1010
Rev 3.0

Package Dimensions and Orientation

3 x 3 x 0.9 mm LGA

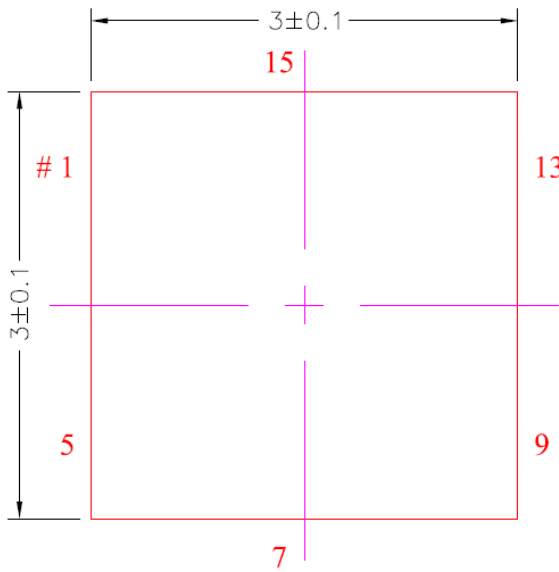

TOP VIEW

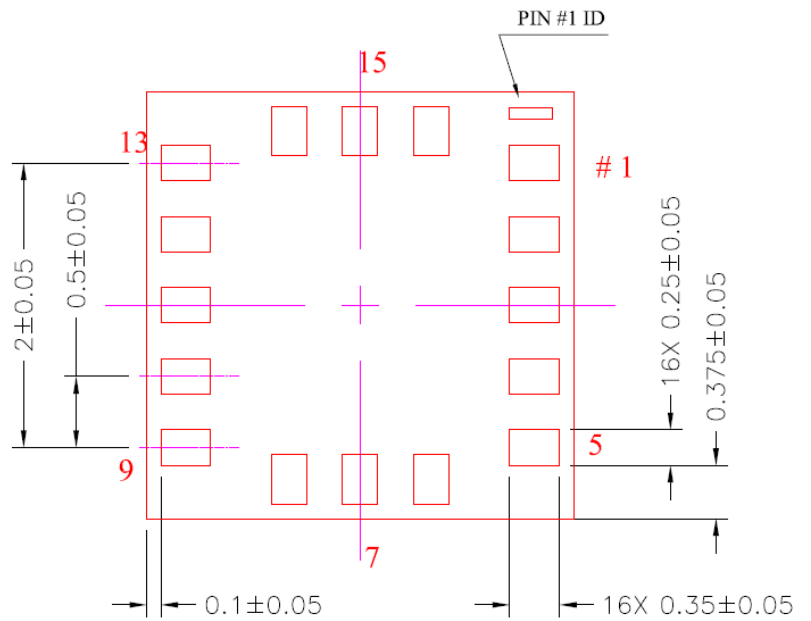

BOTTOM VIEW

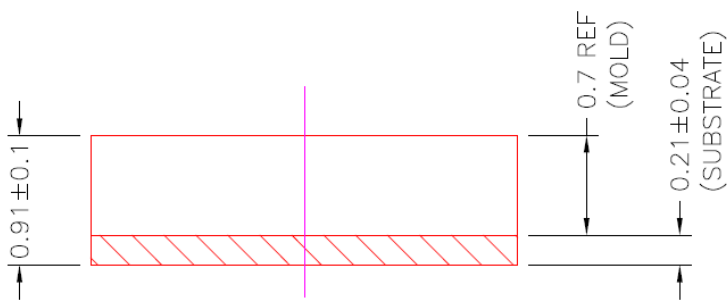

SIDE VIEW

All dimensions and tolerances conform to ASME Y14.5M-1994

	<p align="center">± 2g / 4g / 6g / 8g Tri-axis Digital Accelerometer Specifications</p>	<p align="center">PART NUMBER: KXCNL-1010 Rev 3.0</p>
---	--	--

Orientation

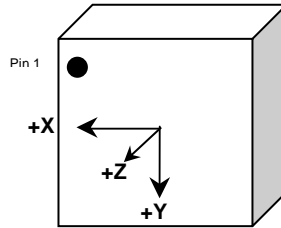

When device is accelerated in +X, +Y or +Z direction, the corresponding output will increase.



± 2g / 4g / 6g / 8g Tri-axis Digital Accelerometer Specifications

PART NUMBER:

KXCNL-1010
Rev 3.0

Static X/Y/Z Output Response versus Orientation to Earth's surface (1g):

SC_1=0, SC_0=0 (± 2g)

Position	1	2	3	4	5	6
Diagram						
X (counts)	0	-1024	0	1024	0	0
Y (counts)	-1024	0	1024	0	0	0
Z (counts)	0	0	0	0	1024	-1024
X-Polarity	0	-	0	+	0	0
Y-Polarity	-	0	+	0	0	0
Z-Polarity	0	0	0	0	+	-

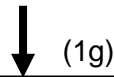

Earth's Surface

Static X/Y/Z Output Response versus Orientation to Earth's surface (1g):

SC_1=0, SC_0=1 (± 4g)

Position	1	2	3	4	5	6
Diagram						
X (counts)	0	-512	0	512	0	0
Y (counts)	-512	0	512	0	0	0
Z (counts)	0	0	0	0	512	-512
X-Polarity	0	-	0	+	0	0
Y-Polarity	-	0	+	0	0	0
Z-Polarity	0	0	0	0	+	-

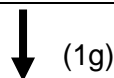

Earth's Surface



± 2g / 4g / 6g / 8g Tri-axis Digital Accelerometer Specifications

PART NUMBER:

KXCNL-1010
Rev 3.0

Static X/Y/Z Output Response versus Orientation to Earth's surface (1g):

SC_1=1, SC_0=0 (± 6g)

Position	1	2	3	4	5	6
Diagram						
X (counts)	0	-341	0	341	0	0
Y (counts)	-341	0	341	0	0	0
Z (counts)	0	0	0	0	341	-341
X-Polarity	0	-	0	+	0	0
Y-Polarity	-	0	+	0	0	0
Z-Polarity	0	0	0	0	+	-

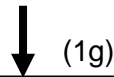

Earth's Surface

Static X/Y/Z Output Response versus Orientation to Earth's surface (1g):

SC_1=1, SC_0=1 (± 8g)

Position	1	2	3	4	5	6
Diagram						
X (counts)	0	-256	0	256	0	0
Y (counts)	-256	0	256	0	0	0
Z (counts)	0	0	0	0	256	-256
X-Polarity	0	-	0	+	0	0
Y-Polarity	-	0	+	0	0	0
Z-Polarity	0	0	0	0	+	-

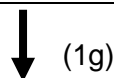

Earth's Surface



± 2g / 4g / 6g / 8g Tri-axis Digital Accelerometer Specifications

PART NUMBER:
KXCNL-1010
Rev 3.0

Land Pattern Recommendation

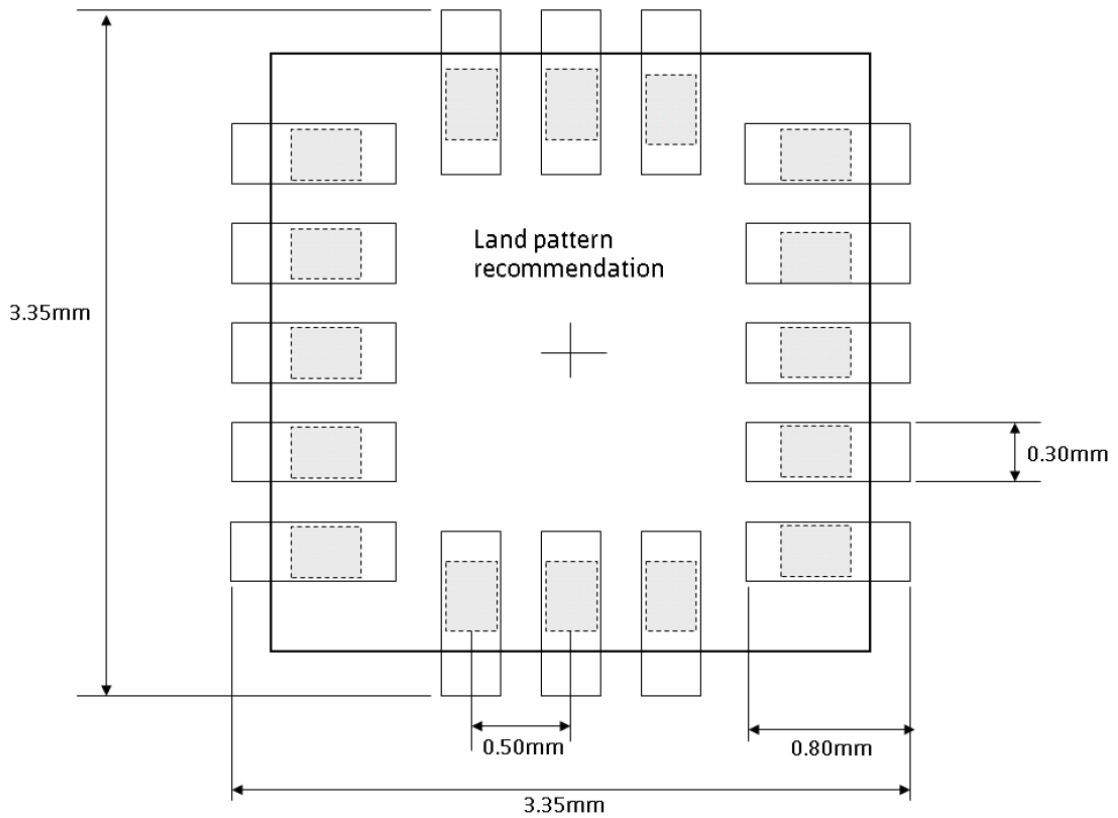

Soldering

Soldering recommendations are available upon request or from www.kionix.com.



± 2g / 4g / 6g / 8g Tri-axis Digital Accelerometer Specifications

PART NUMBER:

KXCNL-1010
Rev 3.0

State Programs

The most important feature of the KXCNL is that it has two independent State Programs which can be programmed by the user to produce interrupts and peak values.

A State Program follows a structure of successive states. From each state (n) it is only possible to have a transition to the next state (n+1) or to the state pointed to by the Reset Pointer (state 1). Transition to the Reset Point happens when the “RESET condition” is true. Transition to the next step happens when “NEXT condition” is true. An interrupt is sent when the Output/Stop/Continue state is reached.

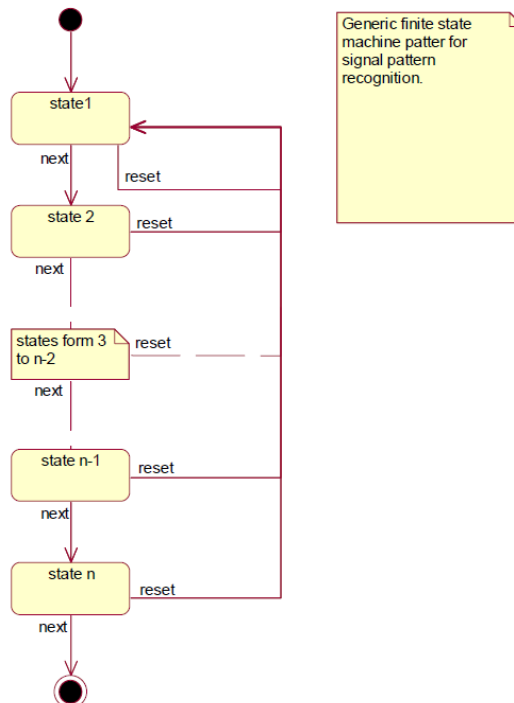

In the KXCNL, a State Program is a series of states, parameters and internal memories running an algorithm in its own logic machine. Two independent State Program areas are defined (State Program 1 and State Program 2).

- Each program can be one shot run or continuously running.
- Outputs of program are internal interrupt signal and interrupt source information.
- Program code steps and parameter sets are loaded into fixed register memory space by the host.
- Input data comes from measurement/signal blocks according ODR and DES2 timing definitions.

One sample is the timing base for the NEXT and RESET conditions. State Programs 1 and 2 are running independently or synchronized but with same input data.

Interrupts are the main output of the State Programs. According program flow, the channel that triggered the interrupt also memorizes its peak (highest or lowest) value.



± 2g / 4g / 6g / 8g Tri-axis Digital Accelerometer Specifications

PART NUMBER:
KXCNL-1010
Rev 3.0

State Program 1 and 2 are identical and exactly working same manners with some exceptions as extra sub functionalities:

- State Program 2 has decimator functionality.
- State Program 2 has a difference (DIFF) functionality/filter. The DIFF filter can be configured with two settings:
 - Difference between current and previous data values (X,Y,Z)
 - Difference between current data values and a constant
- When DIFF functionality selected in State Program 2, vector calculated value (V) is left intact.

State Programs can be debugged with simple step method and host assistance. When register /CNTL1, bit DEBUG == 1, normal measurement data is not fed to the State Programs. Instead, the host feeds manual data to the debug input registers (/X,Y,Z_DEBUG) to imitate measurement data. This debug data is sent to the state programs after writing the /Z_DEBUG register (stepping command like clock).

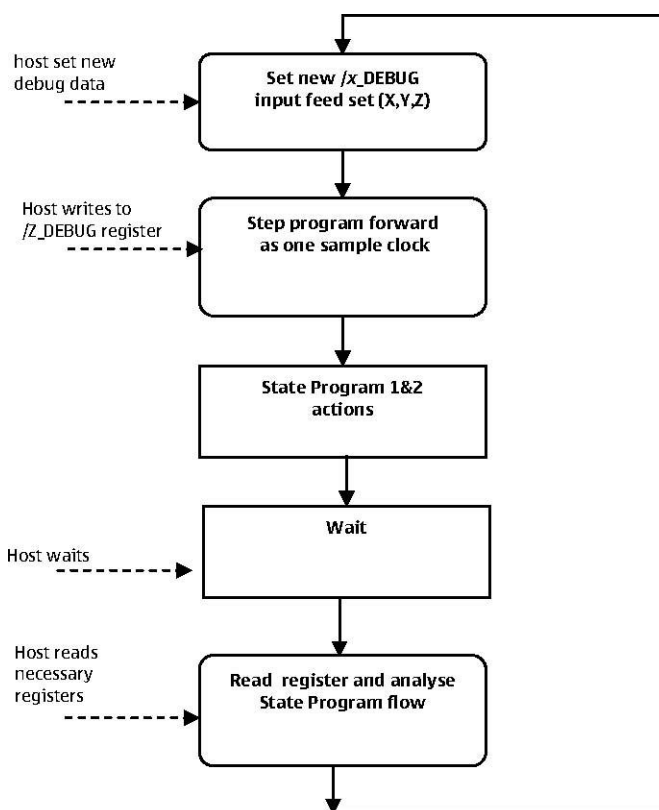

Debug (input) data is feed to State Programs via registers:

- /X_DEBUG = debug feed for x - channel
- /Y_DEBUG = debug feed for y - channel
- /Z_DEBUG = debug feed for z - channel



± 2g / 4g / 6g / 8g Tri-axis Digital Accelerometer Specifications

PART NUMBER:
KXCNL-1010
Rev 3.0

Signal path

The acceleration measurement data flows through several paths according customizable setup of the KXCNL.

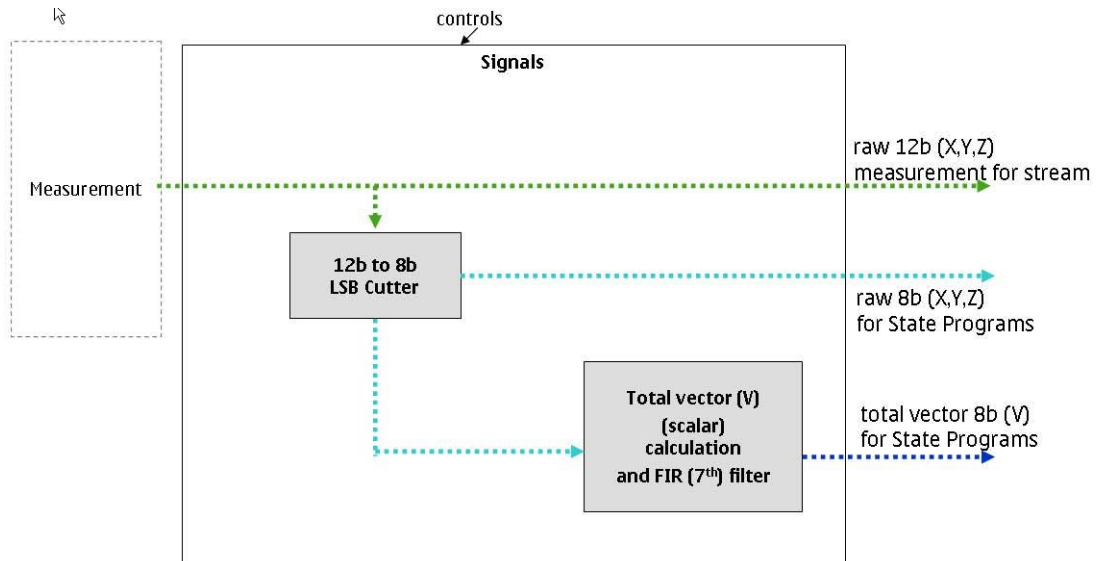

Real acceleration measurement data is available to external applications through the 12-bit /OUT_X, /OUT_Y, and /OUT_Z registers. Data is provided at the selected ODR.

The Integrated Functions of the KXCNL are not using the raw 12-bit data. There are several other data forms available for the Integrated Interrupt Functions (State Programs). Internal data sets in 8-bit format for State Programs usage are:

- Raw (X,Y,Z) acceleration data limited in range from -127 to +127
- Vector (V), calculated and filtered (if enabled), limited to range from -127 to +127
- DIFF is data process method which calculates the difference of the current (X,Y,Z) data measurement to the previous (X,Y,Z) data measurement or the difference of the current (X,Y,Z) data measurement to set of constants. (Available only for State Program 2)

Vector calculation and filter

Total (3D) vector length is calculated with an approximation formula. The calculated vector length result is filtered with an adjustable Band Pass filter. The vector approximation formulas are the following:

$$a1 = |x| + |y| + |z|$$

$$a2 = \max(|x|, |y|, |z|)$$

$$v_{raw} = (45 * a1 + 77 * a2) / 256$$

where:



± 2g / 4g / 6g / 8g Tri-axis Digital Accelerometer Specifications

PART NUMBER:

KXCNL-1010
Rev 3.0

- x, y, z are the 8-bit measured acceleration values limited in range from -127 to +127.
- $a1$ and $a2$ are temporary maximum 16-bit values.
- 45 and 77 are fixed 8-bit constants.
- 256 is the scale factor for the calculation.
- v_{raw} is the vector length, maximum 16-bit scalar temporary value.
- If filtering is not enabled, v_{raw} is fed to the State Programs as V after a limiter of -127 to +127.

Vector filter:

When enabled, the 16-bit vector scalar (v_{raw}) data from the vector calculation phase is passed through a band pass filter. The target corner frequency for the band pass filter is 0.5Hz to 10Hz (in ODR5, 100Hz). ODR selection affects the corner frequencies so ODR5 as 100Hz is the main time base for the vector filter. Filter coefficients are adjustable. The calculation is performed with maximum 16-bit temporary values.

FIR filter, 7 orders (8 taps)

- 4 asymmetric coefficients (8b wide constants)
- 8 tap filter as 4x2 structure
 - $/VFC_1, /VFC_2, /VCF_3, /VCF_4$ and
 - $-/VFC_1, -/VFC_2, -/VCF_3, -/VCF_4$
 - Reference construction: (53,127,127,53, -53,-127,-127,-53)
- Scale factor for filter output (temporary value) is 256 (16b to 8b) and it is limited to range from -127 to +127
- Output is 8b filtered vector scalar (V) data ($/V_I$ internal memory)
- Last 8 input values are kept in $/BUF1$ to $/BUF8$ (8b) internal memories

Vector filter can be enabled or disabled via register $/CNTL4$, bit VFILT setting.

	± 2g / 4g / 6g / 8g Tri-axis Digital Accelerometer Specifications	PART NUMBER: KXCNL-1010 Rev 3.0
---	--	--

Power Modes

The KXCNL has three power modes: Off, Stand-by, and Active. The part exists in one of these three modes at any given time. Off and Stand-by modes have very low current consumptions.

Power Mode	Bus State	V _{IO}	V _{dd}	Function	Outputs
Off	-	OFF	OFF	No sensor activity	Not available
Off	-	ON	OFF	No sensor activity	Not available
Off	-	OFF	ON	No sensor activity	Not available
Stand-by	Active	ON	ON	Waiting activation command	Not available
Active	Active	ON	ON	All functionalities available	Available

Off mode

One or both of the power supplies (V_{dd} or V_{IO}) are not powered. The sensor is completely inactive and not reporting or communicating. Bus communication actions of other devices are not disturbed if they are using the same bus interface as this component.

Initial Startup

The preferred startup sequence is to turn on V_{IO} before V_{dd}, but if V_{dd} is turned on first, the component will not affect the bus communications (no latch-up or other problems during engine system level wake-up).

Power On Reset (POR) is performed every time when:

1. V_{IO} supply is valid
2. V_{dd} power supply is going to valid level

OR

1. V_{IO} power supply is going to valid level
2. V_{dd} supply is valid

When POR occurs, the following registers and signals are set and the part is put into Stand-by mode:

- Interrupt (*INT1/DRDY* and *INT2*) signals are set to inactive (high Z)
- Registers set to default:
 - /STAT
 - /CNTL1 (14h)
 - /CNTL2
 - /CNTL3
 - /CNTL4
 - Offset registers (/OFF_X, /OFF_Y, /OFF_Z)
 - /OUTS1, OUTS2



± 2g / 4g / 6g / 8g Tri-axis Digital Accelerometer Specifications

PART NUMBER:

KXCNL-1010
Rev 3.0

Stand-by mode

The primary function of the stand-by mode is to ensure fast wake-up to active mode and to minimize current consumption. This mode is set as default when both power supplies are applied and the POR function occurs. A Soft Reset command also performs the POR function and puts the part into Stand-by mode.

Stand-by mode is a low power waiting state for fast turn on time. All time critical functionalities are ready to start measurement. Bus communication actions of other components are not disturbed if they are using the same bus. There is only one possible way to change to active mode – a register command via the I²C bus.

Active mode

Stand-by-mode can be changed to Active mode by writing to register /CNTL1, bit PC = 1.

Active mode engages the full functionality of accelerometer measurements. The host also has the ability to change settings in the control registers, readback status registers, and program state machines.

Active mode to Stand-by mode transitions

Two possible methods for transition from Active mode to Stand-by mode can be used.

1. Register /CNTL1, PC =0 command:
 - a. Status register /STAT1 is set to default value
 - b. Interrupt (*INT1/DRDY* and *INT2*) signals are set to inactive (High Z/High impedance)
 - c. Register memory is kept intact
2. Register /CNTL4, STRT=1 command:
 - a. changes are performed to physical signal and register values as POR sequence

When a transition from Active mode to Stand-by mode and back to Active mode has been done by the host:

- If State Program 1 /CNTL2, SM1_EN = 1 (State Program 1 was running in earlier Active mode session), then State Program 1 is disabled during the Stand-by mode and re-enabled when the component is returned to Active mode. However, this resets State Program 1 to its Default Initial position.
- If State Program 2 /CNTL3, SM2_EN = 1 (State Program 2 was running in earlier Active mode session), then State Program 2 is disabled during the Stand-by mode and re-enabled when the component is returned to Active mode. However, this resets State Program 1 to its Default Initial position.

	± 2g / 4g / 6g / 8g Tri-axis Digital Accelerometer Specifications	PART NUMBER: KXCNL-1010 Rev 3.0
---	--	--

KXCNL Digital Interface

The Kionix KXCNL digital accelerometer has the ability to communicate on the I²C digital serial interface bus. This flexibility allows for easy system integration by eliminating analog-to-digital converter requirements and by providing direct communication with system micro-controllers.

The serial interface terms and descriptions as indicated in Table 6 below will be observed throughout this document.

Term	Description
Transmitter	The device that transmits data to the bus.
Receiver	The device that receives data from the bus.
Master	The device that initiates a transfer, generates clock signals, and terminates a transfer.
Slave	The device addressed by the Master.

Table 6. Serial Interface Terminologies

I²C Serial Interface

As previously mentioned, the KXCNL has the ability to communicate on an I²C bus. I²C is primarily used for synchronous serial communication between a Master device and one or more Slave devices. The Master, typically a micro controller, provides the serial clock signal and addresses Slave devices on the bus. The KXCNL always operates as a Slave device during standard Master-Slave I²C operation.

I²C is a two-wire serial interface that contains a Serial Clock (SCL) line and a Serial Data (SDA) line. SCL is a serial clock that is provided by the Master, but can be held low by any Slave device, putting the Master into a wait condition. SDA is a bi-directional line used to transmit and receive data to and from the interface. Data is transmitted MSB (Most Significant Bit) first in 8-bit per byte format, and the number of bytes transmitted per transfer is unlimited. The I²C bus is considered free when both lines are high.

I²C Operation

Transactions on the I²C bus begin after the Master transmits a start condition (S), which is defined as a high-to-low transition on the data line while the SCL line is held high. The bus is considered busy after this condition. The next byte of data transmitted after the start condition contains the Slave Address (SAD) in the seven MSBs (Most Significant Bits), and the LSB (Least Significant Bit) tells whether the Master will be receiving data '1' from the Slave or transmitting data '0' to the Slave. When a Slave Address is sent, each device on the bus compares the seven MSBs with its internally stored address. If they match, the device considers itself addressed by the Master. The Slave Address associated with the KXCNL is:

ADDR pin status	SAD	SAD + Read	SAD + Write
ADDR = 0	0011110 (1Eh)	00111101 (3Dh)	00111100 (3Ch)
ADDR = 1	0011101 (1Dh)	00111011 (3Bh)	00111010 (3Ah)

It is mandatory that receiving devices acknowledge (ACK) each transaction. Therefore, the transmitter must release the SDA line during this ACK pulse. The receiver then pulls the data line low so that it

	<p align="center">± 2g / 4g / 6g / 8g Tri-axis Digital Accelerometer Specifications</p>	<p align="center">PART NUMBER: KXCNL-1010 Rev 3.0</p>
---	--	--

remains stable low during the high period of the ACK clock pulse. A receiver that has been addressed, whether it is Master or Slave, is obliged to generate an ACK after each byte of data has been received. To conclude a transaction, the Master must transmit a stop condition (P) by transitioning the SDA line from low to high while SCL is high. The I²C bus is now free.

Writing to a KXCNL 8-bit Register

Upon power up, the KXCNL enters into stand-by mode. The I²C Master must write to the KXCNL's control registers to set its operational mode. Therefore, when writing to a control register on the I²C bus, as shown Sequence 1 on the following page, the following protocol must be observed: After a start condition, SAD+W transmission, and the KXCNL ACK has been returned, an 8-bit Register Address (RA) command is transmitted by the Master. This command is telling the KXCNL to which 8-bit register the Master will be writing the data. The KXCNL acknowledges the RA and the Master transmits the data to be stored in the 8-bit register. The KXCNL acknowledges that it has received the data and the Master transmits a stop condition (P) to end the data transfer. The data sent to the KXCNL is now stored in the appropriate register. The KXCNL automatically increments the received RA commands and, therefore, multiple bytes of data can be written to sequential registers after each Slave ACK as shown in Sequence 2 on the following page.

Reading from a KXCNL 8-bit Register

When reading data from a KXCNL 8-bit register on the I²C bus, as shown in Sequence 3 on the next page, the following protocol must be observed: The Master first transmits a start condition (S) and the appropriate Slave Address (SAD) with the LSB set at '0' to write. The KXCNL acknowledges and the Master transmits the 8-bit RA of the register it wants to read. The KXCNL again acknowledges, and the Master transmits a repeated start condition (Sr). After the repeated start condition, the Master addresses the KXCNL with a '1' in the LSB (SAD+R) to read from the previously selected register. The Slave then acknowledges and transmits the data from the requested register. The Master does not acknowledge (NACK) it received the transmitted data, but transmits a stop condition to end the data transfer. Note that the KXCNL automatically increments through its sequential registers, allowing data to be read from multiple registers following a single SAD+R command as shown below in Sequence 4 on the following page.

If a receiver cannot transmit or receive another complete byte of data until it has performed some other function, it can hold SCL low to force the transmitter into a wait state. Data transfer only continues when the receiver is ready for another byte and releases SCL.



± 2g / 4g / 6g / 8g Tri-axis Digital Accelerometer Specifications

PART NUMBER:

KXCNL-1010
Rev 3.0

Data Transfer Sequences

The following information clearly illustrates the variety of data transfers that can occur on the I²C bus and how the Master and Slave interact during these transfers. Table 7 defines the I²C terms used during the data transfers.

Term	Definition
S	Start Condition
Sr	Repeated Start Condition
SAD	Slave Address
W	Write Bit
R	Read Bit
ACK	Acknowledge
NACK	Not Acknowledge
RA	Register Address
Data	Transmitted/Received Data
P	Stop Condition

Table 7. I²C Terms

Sequence 1. The Master is writing one byte to the Slave.

Master	S	SAD + W		RA		DATA		P
Slave			ACK		ACK		ACK	

Sequence 2. The Master is writing multiple bytes to the Slave.

Master	S	SAD + W		RA		DATA		DATA		P
Slave			ACK		ACK		ACK		ACK	

Sequence 3. The Master is receiving one byte of data from the Slave.

Master	S	SAD + W		RA		Sr	SAD + R			NACK	P
Slave			ACK		ACK			ACK	DATA		

Sequence 4. The Master is receiving multiple bytes of data from the Slave.

Master	S	SAD + W		RA		Sr	SAD + R			ACK		NACK	P
Slave			ACK		ACK			ACK	DATA		DATA		

	± 2g / 4g / 6g / 8g Tri-axis Digital Accelerometer Specifications	PART NUMBER: KXCNL-1010 Rev 3.0
---	--	--

HS-mode

To enter the 3.4MHz high speed mode of communication, the device must receive the following sequence of conditions from the master: a Start condition followed by a Master code (00001XXX) and a Master Non-acknowledge. Once recognized, the device switches to HS-mode communication. Read/write data transfers then proceed as described in the sequences above. Devices return to the FS-mode after a STOP occurrence on the bus.

Sequence 5. HS-mode data transfer of the Master writing one byte to the Slave.

Speed	FS-mode			HS-mode								FS-mode
Master	S	M-code	NACK	S	SAD + W		RA		DATA		P	
Slave						ACK		ACK		ACK		



± 2g / 4g / 6g / 8g Tri-axis Digital Accelerometer Specifications

PART NUMBER:

KXCNL-1010
Rev 3.0

KXCNL Register Map

Register Name	Type Read/Write	I ² C Read/Write Address	
		Hex	Binary
Reserved ¹		00h – 0Ch	0000 0000 – 0000 1100
/INFO1	R	0Dh	0000 1101
/INFO2	R	0Eh	0000 1110
/WIA	R	0Fh	0000 1111
/OUTX_L	R	10h	0001 0000
/OUTX_H	R	11h	0001 0001
/OUTY_L	R	12h	0001 0010
/OUTY_H	R	13h	0001 0011
/OUTZ_L	R	14h	0001 0100
/OUTZ_H	R	15h	0001 0101
/LC_L	R/W	16h	0001 0110
/LC_H	R/W	17h	0001 0111
/STAT	R	18h	0001 1000
/PEAK1	R	19h	0001 1001
/PEAK2	R	1Ah	0001 1010
/CNTL1	R/W	1Bh	0001 1011
/CNTL2	R/W	1Ch	0001 1100
/CNTL3	R/W	1Dh	0001 1101
/CNTL4	R/W	1Eh	0001 1110
/THRS3	R/W	1Fh	0001 1111
/OFF_X	R/W	20h	0010 0000
/OFF_Y	R/W	21h	0010 0001
/OFF_Z	R/W	22h	0010 0010
Reserved ¹		23h	0010 0011
/CS_X	R/W	24h	0010 0100
/CS_Y	R/W	25h	0010 0101
/CS_Z	R/W	26h	0010 0110
Reserved ¹		27h	0010 0111
/X_DEBUG	R/W	28h	0010 1000
/Y_DEBUG	R/W	29h	0010 1001
/Z_DEBUG	R/W	2Ah	0010 1010
Reserved ¹		2Bh	0010 1011
/VFC_1	R/W	2Ch	0010 1100
/VFC_2	R/W	2Dh	0010 1101
/VFC_3	R/W	2Eh	0010 1110
/VFC_4	R/W	2Fh	0010 1111
Reserved ¹		30h – 3Fh	0011 0000 – 0011 1111
/ST1_1	W	40h	0100 0000
/ST2_1	W	41h	0100 0001
/ST3_1	W	42h	0100 0010
/ST4_1	W	43h	0100 0011
/ST5_1	W	44h	0100 0100
/ST6_1	W	45h	0100 0101
/ST7_1	W	46h	0100 0110
/ST8_1	W	47h	0100 0111
/ST9_1	W	48h	0100 1000
/ST10_1	W	49h	0100 1001
/ST11_1	W	4Ah	0100 1010
/ST12_1	W	4Bh	0100 1011
/ST13_1	W	4Ch	0100 1100
/ST14_1	W	4Dh	0100 1101
/ST15_1	W	4Eh	0100 1110
/ST16_1	W	4Fh	0100 1111
/TIM4_1	W	50h	0101 0000
/TIM3_1	W	51h	0101 0001



± 2g / 4g / 6g / 8g Tri-axis Digital Accelerometer Specifications

PART NUMBER:

KXCNL-1010
Rev 3.0

Register Name	Type Read/Write	I ² C Read/Write Address	
		Hex	Binary
/TIM2_1_L	W	52h	0101 0010
/TIM2_1_H	W	53h	0101 0011
/TIM1_1_L	W	54h	0101 0100
/TIM1_1_H	W	55h	0101 0101
/THRS2_1	W	56h	0101 0110
/THRS1_1	W	57h	0101 0111
Not used – fixed content	R	58h	0101 1000
/SA1	W	59h	0101 1001
/MA1	W	5Ah	0101 1010
/SETT1	W	5Bh	0101 1011
/PPRP1	R	5Ch	0101 1100
/TC1_L	R	5Dh	0101 1101
/TC1_H	R	5Eh	0101 1110
/OUTS1	R	5Fh	0101 1111
/ST1_2	W	60h	0110 0000
/ST2_2	W	61h	0110 0001
/ST3_2	W	62h	0110 0010
/ST4_2	W	63h	0110 0011
/ST5_2	W	64h	0110 0100
/ST6_2	W	65h	0110 0101
/ST7_2	W	66h	0110 0110
/ST8_2	W	67h	0110 0111
/ST9_2	W	68h	0110 1000
/ST10_2	W	69h	0110 1001
/ST11_2	W	6Ah	0110 1010
/ST12_2	W	6Bh	0110 1011
/ST13_2	W	6Ch	0110 1100
/ST14_2	W	6Dh	0110 1101
/ST15_2	W	6Eh	0110 1110
/ST16_2	W	6Fh	0110 1111
/TIM4_2	W	70h	0111 0000
/TIM3_2	W	71h	0111 0001
/TIM2_2_L	W	72h	0111 0010
/TIM2_2_H	W	73h	0111 0011
/TIM1_2_L	W	74h	0111 0100
/TIM1_2_H	W	75h	0111 0101
/THRS2_2	W	76h	0111 0110
/THRS1_2	W	77h	0111 0111
/DES2	W	78h	0111 1000
/SA2	W	79h	0111 1001
/MA2	W	7Ah	0111 1010
/SETT2	W	7Bh	0111 1011
/PPRP2	R	7Ch	0111 1100
/TC2_L	R	7Dh	0111 1101
/TC2_H	R	7Eh	0111 1110
/OUTS2	R	7Fh	0111 1111

Notes:

1. Reserved registers should not be written to.

	± 2g / 4g / 6g / 8g Tri-axis Digital Accelerometer Specifications	PART NUMBER: KXCNL-1010 Rev 3.0
---	--	--

KXCNL Register Descriptions

Information registers

/INFO1

This register can be used for optional supplier information.

R	R	R	R	R	R	R	R	
X	X	X	X	X	X	X	X	Reset Value
Bit7	Bit6	Bit5	Bit4	Bit3	Bit2	Bit1	Bit0	00000000
I ² C Address: 0x0Dh								

/INFO2

A second register can be used for optional supplier information.

R	R	R	R	R	R	R	R	
X	X	X	X	X	X	X	X	Reset Value
Bit7	Bit6	Bit5	Bit4	Bit3	Bit2	Bit1	Bit0	00000000
I ² C Address: 0x0Eh								

/WIA

This register can be used for supplier recognition (Who I Am ID), as it can be factory written to a known byte value. The default value is 0x0Bh.

R	R	R	R	R	R	R	R	
WIA7	WIA6	WIA5	WIA4	WIA3	WIA2	WIA1	WIA0	Reset Value
Bit7	Bit6	Bit5	Bit4	Bit3	Bit2	Bit1	Bit0	00001011
I ² C Address: 0x0Fh								

Accelerometer Outputs

These registers contain up to 12-bits of valid acceleration data for each axis. The data is updated every user-defined ODR period, is protected from overwrite during each read, and can be converted from digital counts to acceleration (g) per Table 8 below. If **/CNTL1, DEBUG == 0**, data is used for State Programs. If **/CNTL1, DEBUG == 1**, data is not fed to State Programs. Data is provided as a signed value (upper part of MSB is sign adjusted) in little Endian form.

12-bit Data	Range = +/-2g	Range = +/-4g	Range = +/-6g	Range = +/-8g
0111 1111 1111	+1.999g	+3.998g	+5.997g	+7.996g
0111 1111 1110	+1.998g	+3.996g	+5.994g	+7.992g
...
0000 0000 0001	+0.001g	+0.002g	+0.003g	+0.004g
0000 0000 0000	0.000g	0.000g	0.000g	0.000g
1111 1111 1111	-0.001g	-0.002g	-0.003g	-0.004g
...



± 2g / 4g / 6g / 8g Tri-axis Digital Accelerometer Specifications

PART NUMBER:
KXCNL-1010
Rev 3.0

12-bit Data	Range = +/-2g	Range = +/-4g	Range = +/-6g	Range = +/-8g
1000 0000 0001	-1.999g	-3.998g	-5.997g	-7.996g
1000 0000 0000	-2.000g	-4.000g	-6.000g	-8.000g

Table 8. Acceleration (g) Calculation

/OUTX_L

X-axis accelerometer output least significant byte

R	R	R	R	R	R	R	R
XOUTD7	XOUTD6	XOUTD5	XOUTD4	XOUTD3	XOUTD2	XOUTD1	XOUTD0
Bit7	Bit6	Bit5	Bit4	Bit3	Bit2	Bit1	Bit0
I ² C Address: 0x10h							

/OUTX_H

X-axis accelerometer output most significant byte

R	R	R	R	R	R	R	R
XOUTD11	XOUTD11	XOUTD11	XOUTD11	XOUTD11	XOUTD10	XOUTD9	XOUTD8
Bit7	Bit6	Bit5	Bit4	Bit3	Bit2	Bit1	Bit0
I ² C Address: 0x11h							

/OUTY_L

Y-axis accelerometer output least significant byte

R	R	R	R	R	R	R	R
YOUTD7	YOUTD6	YOUTD5	YOUTD4	YOUTD3	YOUTD2	YOUTD1	YOUTD0
Bit7	Bit6	Bit5	Bit4	Bit3	Bit2	Bit1	Bit0
I ² C Address: 0x12h							

/OUTY_H

Y-axis accelerometer output most significant byte

R	R	R	R	R	R	R	R
YOUTD11	YOUTD11	YOUTD11	YOUTD11	YOUTD11	YOUTD10	YOUTD9	YOUTD8
Bit7	Bit6	Bit5	Bit4	Bit3	Bit2	Bit1	Bit0
I ² C Address: 0x13h							

/OUTZ_L

Z-axis accelerometer output least significant byte

R	R	R	R	R	R	R	R
ZOUTD7	ZOUTD6	ZOUTD5	ZOUTD4	ZOUTD3	ZOUTD2	ZOUTD1	ZOUTD0
Bit7	Bit6	Bit5	Bit4	Bit3	Bit2	Bit1	Bit0
I ² C Address: 0x14h							



± 2g / 4g / 6g / 8g Tri-axis Digital Accelerometer Specifications

PART NUMBER:

KXCNL-1010
Rev 3.0

/OUTZ_H

Z-axis accelerometer output most significant byte

R	R	R	R	R	R	R	R
ZOUTD11	ZOUTD11	ZOUTD11	ZOUTD11	ZOUTD11	ZOUTD10	ZOUTD9	ZOUTD8
Bit7	Bit6	Bit5	Bit4	Bit3	Bit2	Bit1	Bit0
I ² C Address: 0x15h							

Long Counter

These two registers contain up to 16-bits of long counter information.

/LC_L

Long counter least significant byte

R	R	R	R	R	R	R	R	
LC7	LC6	LC5	LC4	LC3	LC2	LC1	LC0	Reset Value
Bit7	Bit6	Bit5	Bit4	Bit3	Bit2	Bit1	Bit0	11111111
I ² C Address: 0x16h								

/LC_H

Long counter most significant byte

R	R	R	R	R	R	R	R	
LC15	LC14	LC13	LC12	LC11	LC10	LC9	LC8	Reset Value
Bit7	Bit6	Bit5	Bit4	Bit3	Bit2	Bit1	Bit0	11111111
I ² C Address: 0x17h								

/LC counter = -01h, Status: /LC is not valid, counting stopped
 /LC counter = 00h, Status: /LC counter is full, interrupt happens and -01h will be set to counter
 /LC counter > 00h, Status: /LC counting

Reading of the /LC counter resets the /STAT, LONG flag to default (0).



± 2g / 4g / 6g / 8g Tri-axis Digital Accelerometer Specifications

PART NUMBER:
KXCNL-1010
Rev 3.0

/STAT

This register reports the status of the accelerometer output.

R	R	R	R	R	R	R	R	
LONG	SYNCW	SYNC1	SYNC2	INT_SM1	INT_SM2	DOR	DRDY	Reset Value
Bit7	Bit6	Bit5	Bit4	Bit3	Bit2	Bit1	Bit0	00000000
								I ² C Address: 0x18h

LONG is the long counter interrupt and is common to both State Programs. Reset to default value by reading /LC register.

LONG = 0 – no interrupt

LONG = 1 – Long Counter /LC interrupt flag

SYNCW provides common information for OUTW host action waiting. Reset to default value when OUTSy register (State Program 1 or 2) is read.

SYNCW = 0 – no actions are waiting from the Host

SYNCW = 1 – Host action is waiting after OUTW command.

SYNC1 reports the synchronization status of State Program 1.

SYNC1 = 0 – State Program 1 running normally.

SYNC1 = 1 – State Program 1 stopped and waiting for restart request from State Program 2.

SYNC2 reports the synchronization status of State Program 2.

SYNC2 = 0 – State Program 2 running normally.

SYNC2 = 1 – State Program 2 stopped and waiting for restart request from State Program 1.

INT_SM1 reports the interrupt status of State Program 1. Interrupt information is released/reset when /OUTS1 register read.

INT_SM1 = 0 – No State Program 1 interrupt.

INT_SM1 = 1 – State Program 1 interrupt.

INT_SM2 reports the interrupt status of State Program 2. Interrupt information is released/reset when /OUTS2 register read.

INT_SM2 = 0 – No State Program 2 interrupt.

INT_SM2 = 1 – State Program 2 interrupt.

DOR reports a data overrun condition when the stream data is not read from the output registers before the next data samples are starting to be measured. This data overrun bit is reset when the next sample is ready.

DOR = 0 – No data overrun.

DOR = 1 – Data overrun.

DRDY reports the data ready condition of the streaming data.

DRDY = 0 – Data not ready.

DRDY = 1 – Data ready.

	± 2g / 4g / 6g / 8g Tri-axis Digital Accelerometer Specifications	PART NUMBER: KXCNL-1010 Rev 3.0
---	--	--

/PEAK1

Peak detector value for Next condition of State Program 1. State Program 1 stores the highest/lowest peak data value to this register. /PEAK1 value is reset when REL command occurs or new initial start occurs.

R	R	R	R	R	R	R	R	
PEAK1_7	PEAK1_6	PEAK1_5	PEAK1_4	PEAK1_3	PEAK1_2	PEAK1_1	PEAK1_0	Reset Value
Bit7	Bit6	Bit5	Bit4	Bit3	Bit2	Bit1	Bit0	00000000
I ² C Address: 0x19h								

/PEAK2

Peak detector value for Next condition of State Program 2. State Program 2 stores the highest/lowest peak data value to this register. /PEAK2 value is reset when REL command occurs or new initial start occurs.

R	R	R	R	R	R	R	R	
PEAK2_7	PEAK2_6	PEAK2_5	PEAK2_4	PEAK2_3	PEAK2_2	PEAK2_1	PEAK2_0	Reset Value
Bit7	Bit6	Bit5	Bit4	Bit3	Bit2	Bit1	Bit0	00000000
I ² C Address: 0x1Ah								

/CNTL1

Read/write control register that controls the main feature set.

R/W	R/W	R/W	R/W	R/W	R/W	R/W	R/W	
PC	SC_1	SC_0	ODR_2	ODR_1	ODR_0	DEBUG	IEN	Reset Value
Bit7	Bit6	Bit5	Bit4	Bit3	Bit2	Bit1	Bit0	00010100
I ² C Address: 0x1Bh								

PC controls the operating mode of the KXCNL.

PC = 0 – stand-by mode

PC = 1 – operating (active) mode

SC_1, SC_0 sets the g-range for the accelerometer outputs per Table 12. The default g-range is 2 g.

SC_1	SC_0	g-range
0	0	2 g
0	1	4 g
1	0	6 g
1	1	8 g

Table 12. g-range

ODR_2, ODR_1, ODR_0 sets the output data rate for the accelerometer outputs per Table 12. The default ODR is 100Hz.



± 2g / 4g / 6g / 8g Tri-axis Digital Accelerometer Specifications

PART NUMBER:
KXCNL-1010
Rev 3.0

Name	ODR_2	ODR_1	ODR_0	Output Data Rate	Filter cf
ODR0	0	0	0	3.125 Hz	None
ODR1	0	0	1	6.25 Hz	None
ODR2	0	1	0	12.5 Hz	None
ODR3	0	1	1	25 Hz	None
ODR4	1	0	0	50 Hz	None
ODR5	1	0	1	100 Hz	50 Hz
ODR6	1	1	0	400 Hz	200 Hz
ODR7	1	1	1	1600 Hz	800 Hz

Table 12. Output Data Rate

DEBUG controls the State Program Step Debug mode of the KXCNL.

DEBUG = 0 – normal operation of State Programs with /OUTX, /OUTY, and /OUTZ stream data registers are fed to State Programs.

DEBUG = 1 – debug stepping of State Programs with /OUTX, /OUTY, and /OUTZ stream data registers not fed to State Programs. Debug inputs are fetched from /X, Y, Z_DEBUG registers. One step of the State Programs is processed with the write of /Z_DEBUG.

IEN is the main interrupt enable switch to allow State Programs to route interrupts to INT1/DRDY and INT2 pads.

IEN = 0 – physical interrupts disabled.

IEN = 1 – physical interrupts enabled.

/CNTL2

Read/write control register that controls the State Program 1.

R/W	R/W	R/W	R/W	R/W	R/W	R/W	R/W	
HYST2_1	HYST1_1	HYST0_1	0	SM1_PIN	0	0	SM1_EN	Reset Value
Bit7	Bit6	Bit5	Bit4	Bit3	Bit2	Bit1	Bit0	00000000
I ² C Address: 0x1Ch								

HYST2_1, HYST1_1, HYST0_1 sets the (unsigned) hysteresis limit which is added or subtracted from the threshold value in State Program 1.

000 = 0 LSB (default)

111 = 7 LSB (maximum hysteresis)

SM1_PIN controls the routing of the State Program 1 interrupt.

SM1_PIN = 0 – State Program 1 interrupt routed to INT1

SM1_PIN = 1 – State Program 1 interrupt routed to INT2

SM1_EN enables State Program 1. Changing this bit from a 0 to a 1 initiates State Program 1. State Program 1 can control this bit according to the program code.



± 2g / 4g / 6g / 8g Tri-axis Digital Accelerometer Specifications

PART NUMBER:
KXCNL-1010
Rev 3.0

SM1_EN = 0 – State Program 1 disabled. All State Program 1 related temporary memories and registers are left intact.
SM1_EN = 1 – State Program 1 enabled. Default Initial Start-task of State Program 1 is started.

/CNTL3

Read/write control register that controls the State Program 2.

R/W	R/W	R/W	R/W	R/W	R/W	R/W	R/W	
HYST2_2	HYST1_2	HYST0_2	0	SM2_PIN	0	0	SM2_EN	Reset Value
Bit7	Bit6	Bit5	Bit4	Bit3	Bit2	Bit1	Bit0	00000000
I ² C Address: 0x1Dh								

HYST2_2, HYST1_2, HYST0_2 sets the (unsigned) hysteresis limit which is added or subtracted from the threshold value in State Program 2.
000 = 0 LSB (default)
111 = 7 LSB (maximum hysteresis)

SM2_PIN controls the routing of the State Program 2 interrupt.
SM2_PIN = 0 – State Program 2 interrupt routed to INT1
SM2_PIN = 1 – State Program 2 interrupt routed to INT2

SM2_EN enables State Program 2. Changing this bit from a 0 to a 1 initiates State Program 2. State Program 2 can control this bit according to the program code.
SM2_EN = 0 – State Program 2 disabled. All State Program 2 related temporary memories and registers are left intact.
SM2_EN = 1 – State Program 2 enabled. Default Initial Start-task of State Program 2 is started.

/CNTL4

Read/write control register that controls several functions of the KXCNL.

R/W	R/W	R/W	R/W	R/W	R/W	R/W	R/W	
DR_EN	IEA	IEL	INT2_EN	INT1_EN	VFILT	STP	STRT	Reset Value
Bit7	Bit6	Bit5	Bit4	Bit3	Bit2	Bit1	Bit0	00000000
I ² C Address: 0x1Eh								

DR_EN sends the data ready signal (DRDY) to the INT1 pin.
DR_EN = 0 Data Ready signal is not connected to INT1.
DR_EN = 1 Data Ready signal is connected to INT1 and overrides any other interrupt settings.

IEA controls the polarity of interrupt signals.
IEA = 0 – Interrupt signals active LOW.

	± 2g / 4g / 6g / 8g Tri-axis Digital Accelerometer Specifications	PART NUMBER: KXCNL-1010 Rev 3.0
---	--	--

IEA = 1 – Interrupt signals active HIGH.

IEL controls the latching state of interrupt signals.

IEA = 0 – Interrupt signals are latched.

IEA = 1 – Interrupt signals are pulsed.

INT2_EN enables the INT2 pin.

INT2_EN = 0 – INT2 signal disabled. INT2 pin in high-Z state.

INT2_EN = 1 – INT2 signal enabled and signal is fully functional. \CNTL1, IEN must be taken into account also.

INT1_EN enables the INT1/DRDY pin.

INT1_EN = 0 – INT1/DRDY signal disabled. INT1/DRDY pin in high-Z state.

INT1_EN = 1 – INT1/DRDY signal enabled and signal is fully functional. \CNTL1, IEN or /CNTL4, DR_EN must be taken into account also.

VFILT enables or disables the Vector Filter.

VFILT = 0 – Vector filter disabled.

VFILT = 1 – Vector filter enabled.

STP controls the activation of self test.

STP = 0 – Normal operation with no Self Test effect.

STP = 1 – Positive Self Test effect.

STRT performs a Soft Reset of the KXCNL if set to a 1. Similar to POR, defaults for registers are loaded from internal memory. Once the reset is complete, this bit is set to 0.

/THRS3

Read/write register that contains the common threshold for overrun detection. This threshold is always unsigned (abs) regardless of /SETTy, ABS settings and is common to both State Programs. If any axis value exceeds /THRS3 limit (regardless /TAMxAy status), then the RESET action (/PPy=/RPy) and the RESET Initial Start task immediately occur.

R/W	R/W	R/W	R/W	R/W	R/W	R/W	R/W	
THRS3_7	THRS3_6	THRS3_5	THRS3_4	THRS3_3	THRS3_2	THRS3_1	THRS3_0	Reset Value
Bit7	Bit6	Bit5	Bit4	Bit3	Bit2	Bit1	Bit0	00000000
I ² C Address: 0x1Fh								

Offset correction

The following three registers contain up to 8-bits of offset correction for each axis. Because there are typically offset drifts after solder reflow, there is sometimes a need to zero or normalize the outputs for better application performance. These signed offset correction values are multiplied by 2 and subtracted from the outputs provided to the State Programs and to the streaming 12-bit data registers.



± 2g / 4g / 6g / 8g Tri-axis Digital Accelerometer Specifications

PART NUMBER:
KXCNL-1010
Rev 3.0

/OFF_X

X-axis accelerometer offset correction

R/W	R/W	R/W	R/W	R/W	R/W	R/W	R/W	
OFF_X7	OFF_X6	OFF_X5	OFF_X4	OFF_X3	OFF_X2	OFF_X1	OFF_X0	Reset Value
Bit7	Bit6	Bit5	Bit4	Bit3	Bit2	Bit1	Bit0	00000000
							I ² C Address:	0x20h

/OFF_Y

Y-axis accelerometer offset correction

R/W	R/W	R/W	R/W	R/W	R/W	R/W	R/W	
OFF_Y7	OFF_Y6	OFF_Y5	OFF_Y4	OFF_Y3	OFF_Y2	OFF_Y1	OFF_Y0	Reset Value
Bit7	Bit6	Bit5	Bit4	Bit3	Bit2	Bit1	Bit0	00000000
							I ² C Address:	0x21h

/OFF_Z

Z-axis accelerometer offset correction

R/W	R/W	R/W	R/W	R/W	R/W	R/W	R/W	
OFF_Z7	OFF_Z6	OFF_Z5	OFF_Z4	OFF_Z3	OFF_Z2	OFF_Z1	OFF_Z0	Reset Value
Bit7	Bit6	Bit5	Bit4	Bit3	Bit2	Bit1	Bit0	00000000
							I ² C Address:	0x22h

Constant Shift

The following three registers contain up to 8-bits of constant shift data for each axis. The constant shift acts like a temporary offset shift and is used for the DIFF function available only inside State Program 2.

/CS_X

X-axis accelerometer constant shift

R/W	R/W	R/W	R/W	R/W	R/W	R/W	R/W	
CS_X7	CS_X6	CS_X5	CS_X4	CS_X3	CS_X2	CS_X1	CS_X0	Reset Value
Bit7	Bit6	Bit5	Bit4	Bit3	Bit2	Bit1	Bit0	00000000
							I ² C Address:	0x24h



± 2g / 4g / 6g / 8g Tri-axis Digital Accelerometer Specifications

PART NUMBER:
KXCNL-1010
Rev 3.0

/CS_Y

Y-axis accelerometer constant shift

R/W	R/W	R/W	R/W	R/W	R/W	R/W	R/W	
CS_Y7	CS_Y6	CS_Y5	CS_Y4	CS_Y3	CS_Y2	CS_Y1	CS_Y0	Reset Value
Bit7	Bit6	Bit5	Bit4	Bit3	Bit2	Bit1	Bit0	00000000
							I ² C Address:	0x25h

/CS_Z

Z-axis accelerometer constant shift

R/W	R/W	R/W	R/W	R/W	R/W	R/W	R/W	
CS_Z7	CS_Z6	CS_Z5	CS_Z4	CS_Z3	CS_Z2	CS_Z1	CS_Z0	Reset Value
Bit7	Bit6	Bit5	Bit4	Bit3	Bit2	Bit1	Bit0	00000000
							I ² C Address:	0x26h

Debug input

The following three registers contain 8-bits of debug input data for each axis. If /CNTL1, DEBUG == 1, data from these registers is fed to the State Programs when /OUTSx is read (as step command).

/X_DEBUG

X-axis accelerometer debug input

R/W	R/W	R/W	R/W	R/W	R/W	R/W	R/W	
X_DEBUG7	X_DEBUG6	X_DEBUG5	X_DEBUG4	X_DEBUG3	X_DEBUG2	X_DEBUG1	X_DEBUG0	Reset Value
Bit7	Bit6	Bit5	Bit4	Bit3	Bit2	Bit1	Bit0	00000000
							I ² C Address:	0x28h

/Y_DEBUG

Y-axis accelerometer debug input

R/W	R/W	R/W	R/W	R/W	R/W	R/W	R/W	
Y_DEBUG7	Y_DEBUG6	Y_DEBUG5	Y_DEBUG4	Y_DEBUG3	Y_DEBUG2	Y_DEBUG1	Y_DEBUG0	Reset Value
Bit7	Bit6	Bit5	Bit4	Bit3	Bit2	Bit1	Bit0	00000000
							I ² C Address:	0x29h

/Z_DEBUG

Z-axis accelerometer debug input

R/W	R/W	R/W	R/W	R/W	R/W	R/W	R/W	
Z_DEBUG7	Z_DEBUG6	Z_DEBUG5	Z_DEBUG4	Z_DEBUG3	Z_DEBUG2	Z_DEBUG1	Z_DEBUG0	Reset Value
Bit7	Bit6	Bit5	Bit4	Bit3	Bit2	Bit1	Bit0	00000000
							I ² C Address:	0x2Ah



± 2g / 4g / 6g / 8g Tri-axis Digital Accelerometer Specifications

PART NUMBER:

KXCNL-1010
Rev 3.0

Vector filter coefficients

Total acceleration vector length is calculated with an approximation formula. The calculated vector length result is filtered with an adjustable band pass filter. The following four registers contain 8-bit vector filter coefficients.

VFC_1

Vector calculation filter coefficient 1

R/W	R/W	R/W	R/W	R/W	R/W	R/W	R/W	
VFC1_7	VFC1_6	VFC1_5	VFC1_4	VFC1_3	VFC1_2	VFC1_1	VFC1_0	Reset Value
Bit7	Bit6	Bit5	Bit4	Bit3	Bit2	Bit1	Bit0	00000000
							I ² C Address:	0x2Ch

VFC_2

Vector calculation filter coefficient 2

R/W	R/W	R/W	R/W	R/W	R/W	R/W	R/W	
VFC2_7	VFC2_6	VFC2_5	VFC2_4	VFC2_3	VFC2_2	VFC2_1	VFC2_0	Reset Value
Bit7	Bit6	Bit5	Bit4	Bit3	Bit2	Bit1	Bit0	00000000
							I ² C Address:	0x2Dh

VFC_3

Vector calculation filter coefficient 3

R/W	R/W	R/W	R/W	R/W	R/W	R/W	R/W	
VFC3_7	VFC3_6	VFC3_5	VFC3_4	VFC3_3	VFC3_2	VFC3_1	VFC3_0	Reset Value
Bit7	Bit6	Bit5	Bit4	Bit3	Bit2	Bit1	Bit0	00000000
							I ² C Address:	0x2Eh

VFC_4

Vector calculation filter coefficient 4

R/W	R/W	R/W	R/W	R/W	R/W	R/W	R/W	
VFC4_7	VFC4_6	VFC4_5	VFC4_4	VFC4_3	VFC4_2	VFC4_1	VFC4_0	Reset Value
Bit7	Bit6	Bit5	Bit4	Bit3	Bit2	Bit1	Bit0	00000000
							I ² C Address:	0x2Fh



± 2g / 4g / 6g / 8g Tri-axis Digital Accelerometer Specifications

PART NUMBER:

KXCNL-1010
Rev 3.0

State Program 1

The following 32 registers pertain to State Program 1. They contain the program code, timers, thresholds, masks, settings, and outputs.

Register Name	I ² C Address	Read/Write	Name	Description
/ST1_1	0x40	-/W	Step 1	code
/ST2_1	0x41	-/W	Step 2	code
/ST3_1	0x42	-/W	Step 3	code
/ST4_1	0x43	-/W	Step 4	code
/ST5_1	0x44	-/W	Step 5	code
/ST6_1	0x45	-/W	Step 6	code
/ST7_1	0x46	-/W	Step 7	code
/ST8_1	0x47	-/W	Step 8	code
/ST9_1	0x48	-/W	Step 9	code
/ST10_1	0x49	-/W	Step 10	code
/ST11_1	0x4A	-/W	Step 11	code
/ST12_1	0x4B	-/W	Step 12	code
/ST13_1	0x4C	-/W	Step 13	code
/ST14_1	0x4D	-/W	Step 14	code
/ST15_1	0x4E	-/W	Step 15	code
/ST16_1	0x4F	-/W	Step 16	code
/TIM4_1	0x50	-/W	Timer 4	General timer parameter, unsigned value
/TIM3_1	0x51	-/W	Timer 3	General timer parameter, unsigned value
/TIM2_1	0x52	-/W	Timer 2 LSB	General timer parameter, unsigned value
	0x53	-/W	Timer 2 MSB	
/TIM1_1	0x54	-/W	Timer 1 LSB	General timer parameter, unsigned value
	0x55	-/W	Timer 1 MSB	
/THRS2_1	0x56	-/W	Threshold 2	Signed value
/THRS1_1	0x57	-/W	Threshold 1	Signed value



± 2g / 4g / 6g / 8g Tri-axis Digital Accelerometer Specifications

PART NUMBER:

KXCNL-1010
Rev 3.0

/SA1

The register that controls the settings of swap axis and sign masks.

-/W	-/W	-/W	-/W	-/W	-/W	-/W	-/W
P_X	N_X	P_Y	N_Y	P_Z	N_Z	P_V	N_V
Bit7	Bit6	Bit5	Bit4	Bit3	Bit2	Bit1	Bit0
I ² C Address: 0x59h							

P_X is axis mask x+.
P_X = 0 x+ disabled.
P_X = 1 x+ enabled.

N_X is axis mask x-.
N_X = 0 x- disabled.
N_X = 1 x- enabled.

P_Y is axis mask y+.
P_Y = 0 y+ disabled.
P_Y = 1 y+ enabled.

N_Y is axis mask y-.
N_Y = 0 y- disabled.
N_Y = 1 y- enabled.

P_Z is axis mask z+.
P_Z = 0 z+ disabled.
P_Z = 1 z+ enabled.

N_Z is axis mask z-.
N_Z = 0 z- disabled.
N_Z = 1 z- enabled.

P_V is axis mask v+.
P_V = 0 v+ disabled.
P_V = 1 v+ enabled.

N_V is axis mask v-.
N_V = 0 v- disabled.
N_V = 1 v- enabled.



± 2g / 4g / 6g / 8g Tri-axis Digital Accelerometer Specifications

PART NUMBER:

KXCNL-1010
Rev 3.0

/MA1

The register that controls the default settings of axis and sign masks.

-W	-W	-W	-W	-W	-W	-W	-W
P_X	N_X	P_Y	N_Y	P_Z	N_Z	P_V	N_V
Bit7	Bit6	Bit5	Bit4	Bit3	Bit2	Bit1	Bit0

I²C Address: 0x5Ah

P_X is axis mask x+.
P_X = 0 x+ disabled.
P_X = 1 x+ enabled.

N_X is axis mask x-.
N_X = 0 x- disabled.
N_X = 1 x- enabled.

P_Y is axis mask y+.
P_Y = 0 y+ disabled.
P_Y = 1 y+ enabled.

N_Y is axis mask y-.
N_Y = 0 y- disabled.
N_Y = 1 y- enabled.

P_Z is axis mask z+.
P_Z = 0 z+ disabled.
P_Z = 1 z+ enabled.

N_Z is axis mask z-.
N_Z = 0 z- disabled.
N_Z = 1 z- enabled.

P_V is axis mask v+.
P_V = 0 v+ disabled.
P_V = 1 v+ enabled.

N_V is axis mask v-.
N_V = 0 v- disabled.
N_V = 1 v- enabled.



± 2g / 4g / 6g / 8g Tri-axis Digital Accelerometer Specifications

PART NUMBER:
KXCNL-1010
Rev 3.0

/SETT1

The register that controls the State Program 1 flow.

-W	-W	-W	-W	-W	-W	-W	-W
P_DET	THR3_SA	ABS	0	0	THR3_MA	R_TAM	SITR
Bit7	Bit6	Bit5	Bit4	Bit3	Bit2	Bit1	Bit0

I²C Address: 0x5Bh

P_DET is the peak detection control bit.

P_DET = 0 peak detection disabled.

P_DET = 1 peak detection enabled in State Program 1.

THR3_SA controls the reset action when Threshold 3 is exceeded and mask is /SA1.

THR3_SA = 0 no action.

THR3_SA = 1 Exceeding Threshold 3 immediately triggers Reset action if mask is /SA1 (/MASA1 == 1). Every sample and every axis is tested to determine if it exceeds Threshold 3 regardless of the /TAMxA1 value. /THRS3 (register) limit is common for both State Programs.

ABS is the peak absolute threshold enable/disable control.

ABS = 0 unsigned thresholds. Thresholds are symmetric across the zero line.

ABS = 1 signed thresholds in State Program 1. Thresholds are sign dependent.

THR3_MA controls the reset action when Threshold 3 is exceeded and mask is /MA1.

THR3_MA = 0 no action.

THR3_MA = 1 Exceeding Threshold 3 immediately triggers Reset action if mask is /SA1 (/MASA1 == 0). Every sample and every axis is tested to determine if it exceeds Threshold 3 regardless of the /TAMxA1 value. /THRS3 (register) limit is common for both State Programs.

R_TAM is the temporary axis mask and peak state flag release.

R_TAM = 0 no changes for /TAMxA1.

R_TAM = 1 /TAMxA1 released to default after every valid NEXT condition.

SITR is the temporary axis mask and peak state flag release.

SITR = 0 no actions.

SITR = 1 STOP and CONT commands proceeds also output as OUTC command.



± 2g / 4g / 6g / 8g Tri-axis Digital Accelerometer Specifications

PART NUMBER:
KXCNL-1010
Rev 3.0

/PR1

The register contains the program pointer (PP1) address and the reset point (RP1) address. The internal addresses for program flow management are reported in an unsigned 4b+4b value. /PR1_PP1 is the LSB part of byte (/PP1) and /PR1_RP1 is the MSB part of byte (/RP1)

R	R	R	R	R	R	R	R	
RP1_3	RP1_2	RP1_1	RP1_0	PP1_3	PP1_2	PP1_1	PP1_0	Reset Value
Bit7	Bit6	Bit5	Bit4	Bit3	Bit2	Bit1	Bit0	00000000
								I ² C Address: 0x5Ch

/TC1_L

Current timer counter value (unsigned) least significant byte

R	R	R	R	R	R	R	R	
TC1_7	TC1_6	TC1_5	TC1_4	TC1_3	TC1_2	TC1_1	TC1_0	Reset Value
Bit7	Bit6	Bit5	Bit4	Bit3	Bit2	Bit1	Bit0	00000000
								I ² C Address: 0x5Dh

/TC1_H

Current timer counter value (unsigned) most significant byte

R	R	R	R	R	R	R	R	
TC1_15	TC1_14	TC1_13	TC1_12	TC1_11	TC1_10	TC1_9	TC1_8	Reset Value
Bit7	Bit6	Bit5	Bit4	Bit3	Bit2	Bit1	Bit0	00000000
								I ² C Address: 0x5Eh

/OUTS1

The output register containing the main set flags. Reading this register affects the interrupt release function. This register is set to default after the host reads this register.

R	R	R	R	R	R	R	R	
P_X	N_X	P_Y	N_Y	P_Z	N_Z	P_V	N_V	Reset Value
Bit7	Bit6	Bit5	Bit4	Bit3	Bit2	Bit1	Bit0	00000000
								I ² C Address: 0x5Fh

P_X is axis mask x+.
P_X = 0 x+ no show.
P_X = 1 x+ show.

N_X is axis mask x-.
N_X = 0 x- no show.
N_X = 1 x- show.

P_Y is axis mask y+.



± 2g / 4g / 6g / 8g Tri-axis Digital Accelerometer Specifications

PART NUMBER:

KXCNL-1010
Rev 3.0

P_Y = 0 y+ no show.

P_Y = 1 y+ show.

N_Y is axis mask y-.

N_Y = 0 y- no show.

N_Y = 1 y- show.

P_Z is axis mask z+.

P_Z = 0 z+ no show.

P_Z = 1 z+ show.

N_Z is axis mask z-.

N_Z = 0 z- no show.

N_Z = 1 z- show.

P_V is axis mask v+.

P_V = 0 v+ no show.

P_V = 1 v+ show.

N_V is axis mask v-.

N_V = 0 v- no show.

N_V = 1 v- show.



± 2g / 4g / 6g / 8g Tri-axis Digital Accelerometer Specifications

PART NUMBER:

KXCNL-1010
Rev 3.0

State Program 2

The following 32 registers pertain to State Program 2. They contain the program code, timers, thresholds, masks, settings, and outputs.

Register Name	I ² C Address	Read/Write	Name	Description
/ST1_2	0x60	-/W	Step 1	code
/ST2_2	0x61	-/W	Step 2	code
/ST3_2	0x62	-/W	Step 3	code
/ST4_2	0x63	-/W	Step 4	code
/ST5_2	0x64	-/W	Step 5	code
/ST6_2	0x65	-/W	Step 6	code
/ST7_2	0x66	-/W	Step 7	code
/ST8_2	0x67	-/W	Step 8	code
/ST9_2	0x68	-/W	Step 9	code
/ST10_2	0x69	-/W	Step 10	code
/ST11_2	0x6A	-/W	Step 11	code
/ST12_2	0x6B	-/W	Step 12	code
/ST13_2	0x6C	-/W	Step 13	code
/ST14_2	0x6D	-/W	Step 14	code
/ST15_2	0x6E	-/W	Step 15	code
/ST16_2	0x6F	-/W	Step 16	code
/TIM4_2	0x70	-/W	Timer 4	General timer parameter, unsigned value
/TIM3_2	0x71	-/W	Timer 3	General timer parameter, unsigned value
/TIM2_2	0x72	-/W	Timer 2 LSB	General timer parameter, unsigned value
	0x73	-/W	Timer 2 MSB	
/TIM1_2	0x74	-/W	Timer 1 LSB	General timer parameter, unsigned value
	0x75	-/W	Timer 1 MSB	
/THRS2_2	0x76	-/W	Threshold 2	Signed value
/THRS1_2	0x77	-/W	Threshold 1	Signed value



± 2g / 4g / 6g / 8g Tri-axis Digital Accelerometer Specifications

PART NUMBER:

KXCNL-1010
Rev 3.0

/DES2	0x78	-/W	Decimation	Initial decimation counter value
-------	------	-----	------------	----------------------------------

/SA2

The register that controls the settings of swap axis and sign masks.

-/W	-/W	-/W	-/W	-/W	-/W	-/W	-/W
P_X	N_X	P_Y	N_Y	P_Z	N_Z	P_V	N_V
Bit7	Bit6	Bit5	Bit4	Bit3	Bit2	Bit1	Bit0
I ² C Address: 0x79h							

P_X is axis mask x+.
P_X = 0 x+ disabled.
P_X = 1 x+ enabled.

N_X is axis mask x-.
N_X = 0 x- disabled.
N_X = 1 x- enabled.

P_Y is axis mask y+.
P_Y = 0 y+ disabled.
P_Y = 1 y+ enabled.

N_Y is axis mask y-.
N_Y = 0 y- disabled.
N_Y = 1 y- enabled.

P_Z is axis mask z+.
P_Z = 0 z+ disabled.
P_Z = 1 z+ enabled.

N_Z is axis mask z-.
N_Z = 0 z- disabled.
N_Z = 1 z- enabled.

P_V is axis mask v+.
P_V = 0 v+ disabled.
P_V = 1 v+ enabled.

N_V is axis mask v-.
N_V = 0 v- disabled.
N_V = 1 v- enabled.



± 2g / 4g / 6g / 8g Tri-axis Digital Accelerometer Specifications

PART NUMBER:

KXCNL-1010
Rev 3.0

/MA2

The register that controls the default settings of axis and sign masks.

-W	-W	-W	-W	-W	-W	-W	-W
P_X	N_X	P_Y	N_Y	P_Z	N_Z	P_V	N_V
Bit7	Bit6	Bit5	Bit4	Bit3	Bit2	Bit1	Bit0

I²C Address: 0x7Ah

P_X is axis mask x+.
P_X = 0 x+ disabled.
P_X = 1 x+ enabled.

N_X is axis mask x-.
N_X = 0 x- disabled.
N_X = 1 x- enabled.

P_Y is axis mask y+.
P_Y = 0 y+ disabled.
P_Y = 1 y+ enabled.

N_Y is axis mask y-.
N_Y = 0 y- disabled.
N_Y = 1 y- enabled.

P_Z is axis mask z+.
P_Z = 0 z+ disabled.
P_Z = 1 z+ enabled.

N_Z is axis mask z-.
N_Z = 0 z- disabled.
N_Z = 1 z- enabled.

P_V is axis mask v+.
P_V = 0 v+ disabled.
P_V = 1 v+ enabled.

N_V is axis mask v-.
N_V = 0 v- disabled.
N_V = 1 v- enabled.



± 2g / 4g / 6g / 8g Tri-axis Digital Accelerometer Specifications

PART NUMBER:
KXCNL-1010
Rev 3.0

/SETT2

The register that controls the State Program 2 flow.

-W	-W	-W	-W	-W	-W	-W	-W
P_DET	THR3_SA	ABS	RADI	D_CS	THR3_MA	R_TAM	SITR
Bit7	Bit6	Bit5	Bit4	Bit3	Bit2	Bit1	Bit0
I ² C Address: 0x7Bh							

P_DET is the peak detection control bit.

P_DET = 0 peak detection disabled.

P_DET = 1 peak detection enabled in State Program 2.

THR3_SA controls the reset action when Threshold 3 is exceeded and mask is /SA2.

THR3_SA = 0 no action.

THR3_SA = 1 Exceeding Threshold 3 immediately triggers Reset action if mask is /SA2 (/MASA2 == 1). Every sample and every axis is tested to determine if it exceeds Threshold 3 regardless of the /TAMxA2 value. /THRS3 (register) limit is common for both State Programs.

ABS is the peak absolute threshold enable/disable control.

ABS = 0 unsigned thresholds. Thresholds are symmetric across the zero line.

ABS = 1 signed thresholds in State Program 2. Thresholds are sign dependent.

RADI controls difference data mode. Only for State Program 2.

RADI = 0 use raw data

RADI = 1 use difference data in State Program 2.

D_CS DIFF2 or constant shift mode. Only for State Program 2.

D_CS = 0 DIFF2

D_CS = 1 constant shift for DIFF definition

THR3_MA controls the reset action when Threshold 3 is exceeded and mask is /MA2.

THR3_MA = 0 no action.

THR3_MA = 1 Exceeding Threshold 3 immediately triggers Reset action if mask is /SA2 (/MASA2 == 0). Every sample and every axis is tested to determine if it exceeds Threshold 3 regardless of the /TAMxA2 value. /THRS3 (register) limit is common for both State Programs.

R_TAM is the temporary axis mask and peak state flag release.

R_TAM = 0 no changes for /TAMxA2.

R_TAM = 1 /TAMxA2 released to default after every valid NEXT condition.

SITR is the temporary axis mask and peak state flag release.

SITR = 0 no actions.

SITR = 1 STOP and CONT commands proceeds also output as OUTC command.



± 2g / 4g / 6g / 8g Tri-axis Digital Accelerometer Specifications

PART NUMBER:
KXCNL-1010
Rev 3.0

/PR2

The register contains the program pointer (PP2) address and the reset point (RP2) address. The internal addresses for program flow management are reported in an unsigned 4b+4b value. /PR2_PP2 is the LSB part of byte (/PP2) and /PR2_RP2 is the MSB part of byte (/RP2)

R	R	R	R	R	R	R	R	
RP2_3	RP2_2	RP2_1	RP2_0	PP2_3	PP2_2	PP2_1	PP2_0	Reset Value
Bit7	Bit6	Bit5	Bit4	Bit3	Bit2	Bit1	Bit0	00000000
								I ² C Address: 0x7Ch

/TC2_L

Current timer counter value (unsigned) least significant byte

R	R	R	R	R	R	R	R	
TC2_7	TC2_6	TC2_5	TC2_4	TC2_3	TC2_2	TC2_1	TC2_0	Reset Value
Bit7	Bit6	Bit5	Bit4	Bit3	Bit2	Bit1	Bit0	00000000
								I ² C Address: 0x7Dh

/TC2_H

Current timer counter value (unsigned) most significant byte

R	R	R	R	R	R	R	R	
TC2_15	TC2_14	TC2_13	TC2_12	TC2_11	TC2_10	TC2_9	TC2_8	Reset Value
Bit7	Bit6	Bit5	Bit4	Bit3	Bit2	Bit1	Bit0	00000000
								I ² C Address: 0x7Eh

/OUTS2

The output register containing the main set flags. Reading this register affects the interrupt release function. This register is set to default after the host reads this register.

R	R	R	R	R	R	R	R	
P_X	N_X	P_Y	N_Y	P_Z	N_Z	P_V	N_V	Reset Value
Bit7	Bit6	Bit5	Bit4	Bit3	Bit2	Bit1	Bit0	00000000
								I ² C Address: 0x7Fh

P_X is axis mask x+.
P_X = 0 x+ no show.
P_X = 1 x+ show.

N_X is axis mask x-.
N_X = 0 x- no show.
N_X = 1 x- show.

P_Y is axis mask y+.



± 2g / 4g / 6g / 8g Tri-axis Digital Accelerometer Specifications

PART NUMBER:

KXCNL-1010
Rev 3.0

P_Y = 0 y+ no show.

P_Y = 1 y+ show.

N_Y is axis mask y-.

N_Y = 0 y- no show.

N_Y = 1 y- show.

P_Z is axis mask z+.

P_Z = 0 z+ no show.

P_Z = 1 z+ show.

N_Z is axis mask z-.

N_Z = 0 z- no show.

N_Z = 1 z- show.

P_V is axis mask v+.

P_V = 0 v+ no show.

P_V = 1 v+ show.

N_V is axis mask v-.

N_V = 0 v- no show.

N_V = 1 v- show.



± 2g / 4g / 6g / 8g Tri-axis Digital Accelerometer Specifications

PART NUMBER:

KXCNL-1010
Rev 3.0

State Program OP Codes

#	Mnemonic	Explanation	Notes
0h	NOP	No operation	Execution moved to next or reset conditions in state
1h	TI1	Timer 1 valid	Data samples are not evaluated
2h	TI2	Timer 2 valid	Data samples are not evaluated
3h	TI3	Timer 3 valid	Data samples are not evaluated
4h	TI4	Timer 4 valid	Data samples are not evaluated
5h	GNTH1	Any/triggered axis greater than threshold 1	First axis triggers
6h	GNTH2	Any/triggered axis greater than threshold 2	First axis triggers
7h	LNTH1	Any/triggered axis less than or equal to threshold 1	First axis triggers
8h	LNTH2	Any/triggered axis less than or equal to threshold 2	First axis triggers
9h	GTTH1	Any/triggered axis greater than threshold 1	First axis triggers
Ah	LLTH2	All axis less than or equal to threshold 2	First masked axis triggers
Bh	GRTH1	Any/triggered axis greater than to reversed threshold 1	First axis triggers
Ch	LRTH1	Any/triggered axis less than or equal to reversed threshold 1	First axis triggers
Dh	GRTH2	Any/triggered axis greater than to reversed threshold 2	First axis triggers
Eh	LRTH2	Any/triggered axis less than or equal to reversed threshold 2	First axis triggers
Fh	NZERO	Any axis zero crossed	Uses previous data samples sign First axis triggers

Table 1. Conditions

#	Mnemonic	Explanation	Run Scope	Notes
00h	STOP	Stop execution, and resets reset-point to start	Immediately	Output also if enabled
11h	CONT	Continues execution from reset-point	Immediately	Output also if enabled
22h	JMP	Jump address for two Next conditions - 1 st parameter is conditions - 2 nd parameter are addresses for valid conditions	Immediately for command & Sample for conditions	Special (command and conditions)
33h	SRP	Set reset-point to next address / state	Immediately	
44h	CRP	Clear reset-point to start position (to 1 st address)	Immediately	
55h	SETP	Set parameter in register memory - 1 st is address of parameter - 2 nd parameter is new parameter set to address	Immediately	Address parameter is direct absolute pointer to register memory
66h	SETS1	Set new setting to Settings 1 register - 1 st is new settings byte	Immediately	
77h	STHR1	Set new value to /THRS1_y register - 1 st is new settings byte	Immediately	
88h	OUTC	Set outputs to output registers	Immediately output	



± 2g / 4g / 6g / 8g Tri-axis Digital Accelerometer Specifications

PART NUMBER:
KXCNL-1010
Rev 3.0

#	Mnemonic	Explanation	Run Scope	Notes
99h	OUTW	Set outputs to output registers and wait for latch reset from host	Immediately output and Wait (host)	Host driven event
Aah	STHR2	Set new value to /THRS2_y register - 1 st is new settings byte	Immediately	
BBh	DEC	Decrease long counter -1 and validate counter	Immediately	
CCh	SISW	Swaps sign information to opposite in mask and trigger	Immediately	
DDh	REL	Releases temporary output information	Immediately	
Eeh	STHR3	Set new value to /THRS3 register - 1 st is new settings byte	Immediately	
FFh	SSYNC	Set synchronization point to other State program	Immediately and Wait (sync)	Affects both State Programs

Table 2. Commands

#	Mnemonic	Explanation	Run Scope	Notes
12h	SABS0	Set /SETTy, bit ABS = 0. Select unsigned filter	Immediately	
13h	SABS1	Set /SETTy, bit ABS = 1. Select signed filter ON	Immediately	
14h	SELMA	Set /MASAy pointer to May (set MASAy = 0)	Immediately	
21h	SRADI0	Set /SETT2, bit RAD1 = 0. Select raw data mode	Immediately	Only for State Program 2*
23h	SRADI1	Set /SETT2, bit RAD1 = 1. Select difference data mode	Immediately	Only for State Program 2*
24h	SELSA	Set /MASAy pointer to Say (set MASAy = 1)	Immediately	
31h	SCS0	Set /SETT2, bit D_CS = 0. Select DIFF data mode	Immediately	Only for State Program 2*
32h	SCS1	Set /SETT2, bit D_CS = 1. Select Constant Shift data mode	Immediately	Only for State Program 2*
34h	STRAM0	Set /SETTy, bit R_TAM = 0. Temporary Axis Mask /TAMxAy is kept intact	Immediately	
41h	STIM3	Set new value to /TIM3_y register - 1 st is new settings byte	Immediately	
42h	STIM4	Set new value to /TIM4_y register - 1 st is new settings byte	Immediately	
43h	SRTAM1	Set /SETTy, bit R_TAM = 1. Temporary Axis Mask /TAMxAy is released to default after every valid condition	Immediately	

Table 3. Commands (extended set)

***Note:** 21h, 23h, 31h, and 32h are forbidden with State Program 1. When a forbidden OP code exists in State Program y, it will immediately stop/halt (F_Smy_EM = 0).

	± 2g / 4g / 6g / 8g Tri-axis Digital Accelerometer Specifications	PART NUMBER: KXCNL-1010 Rev 3.0
---	--	--

Revision History

REVISION	DESCRIPTION	DATE
1.0	Initial Release	21-Aug-2012
2.0	Updated /SETT2 register to include RADI and D_CS bits	8-Oct-2012
3.0	Added Floor Life Specification	19-Nov-2013

"Kionix" is a registered trademark of Kionix, Inc. Products described herein are protected by patents issued or pending. No license is granted by implication or otherwise under any patent or other rights of Kionix. The information contained herein is believed to be accurate and reliable but is not guaranteed. Kionix does not assume responsibility for its use or distribution. Kionix also reserves the right to change product specifications or discontinue this product at any time without prior notice. This publication supersedes and replaces all information previously supplied.